

# ProTek Systems, Inc.

PROTEK SYSTEMS, INC.  
1250 WALLACE DR UNIT B  
DELRAY BEACH, FL 33444  
TELEPHONE: 800-598-2153  
FAX: 561-395-4771  
SALES@PROTEKMAIL.COM

## CGAM-404 ANTIMICROBIAL CORNER GUARD

### FEATURES:

- ALLOY 5052-H32 .080" ALUMINUM WITH ANTIMICROBIAL POWDER COAT FINISH
- STOCK LENGTHS: 4FT, 8FT, OR 10FT
- CUSTOM WING SIZES AVAILABLE
- CUSTOM HEIGHTS AND ANGLES AVAILABLE
- OTHER FINISHES AVAILABLE

### MOUNTING OPTIONS:

- ADHESIVE:
  - ADH-50 CONSTRUCTION ADHESIVE (SUPPLIED SEPARATELY AS REQUIRED)
- DRILLED:
  - CLEARANCE HOLES FOR #8 FASTENER ABSS-11 #8 X 1 1/2" OVAL HEAD SHEET METAL SCREW AND ABCW-132 STAINLESS CUP WASHER (FASTENERS BY OTHERS).
  - STANDARD SPACING: 3" FROM EACH END AND SPACED EVENLY NOT TO EXCEED 36" O.C.

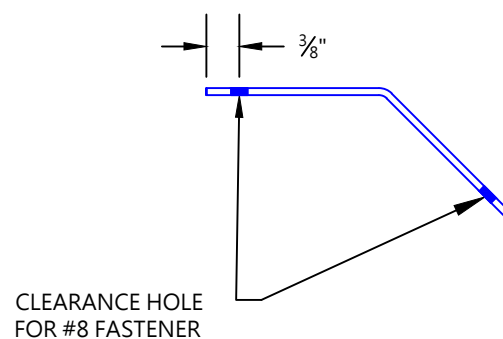
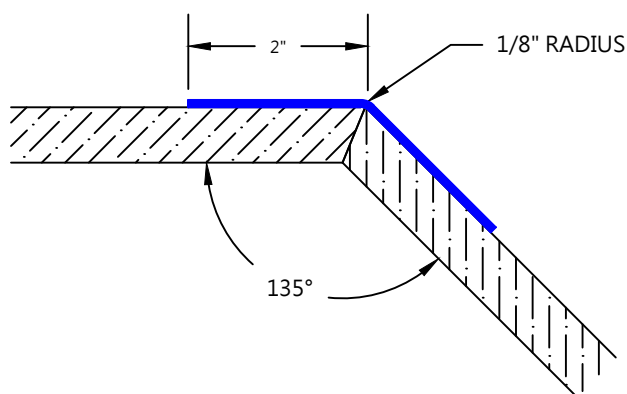
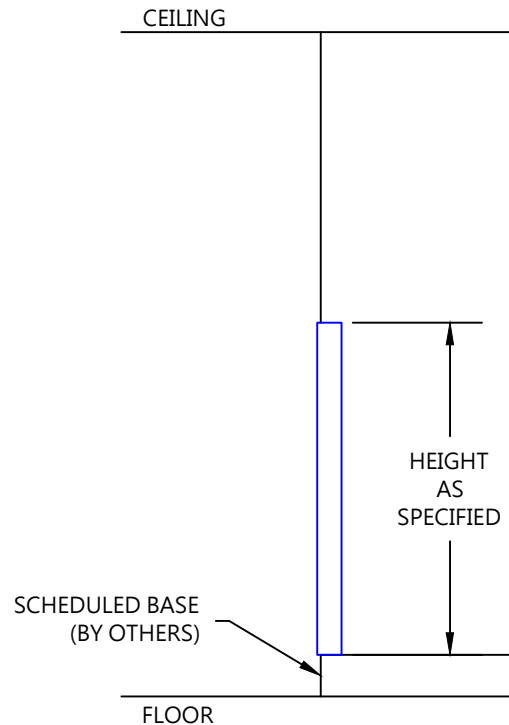

CUSTOMER:

PROJECT:

ARCHITECT:

SALES REP:

**CGAM-404**