

ProTek Systems, Inc.

PROTEK SYSTEMS, INC.
 1250 WALLACE DR UNIT B
 DELRAY BEACH, FL 33444
 TELEPHONE: 800-598-2153
 FAX: 561-395-4771
 SALES@PROTEKMAIL.COM

CRAM-800 ANTIMICROBIAL WALL GUARD

FEATURES:

- COVER: ALLOY 5052-H32 .063" ALUMINUM WITH ANTIMICROBIAL POWDER COAT FINISH
- END PLATES: ALLOY 5052-H32 .125" ALUMINUM WITH ANTIMICROBIAL POWDER COAT FINISH
- BRACKETS: ALLOY 5052-H32 .063" ALUMINUM
- STOCK LENGTHS: 8FT OR 10FT
- ALL RUNS TERMINATE WITH END PLATES
- END PLATES FASTEN DIRECTLY TO WALL BRACKETS
- CUSTOM LENGTHS AND HEIGHTS AVAILABLE
- OTHER FINISHES AVAILABLE
- FASTENERS BY OTHERS

ASSEMBLY:

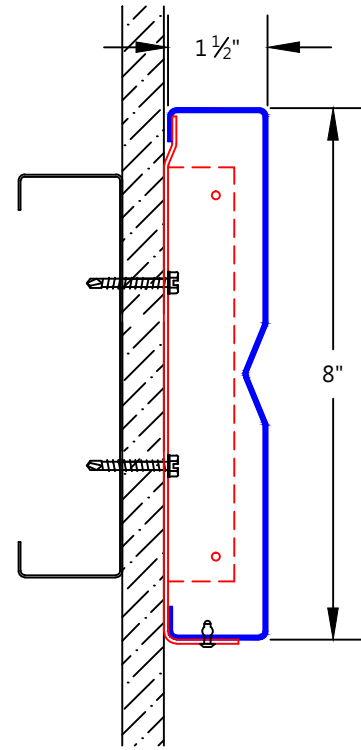
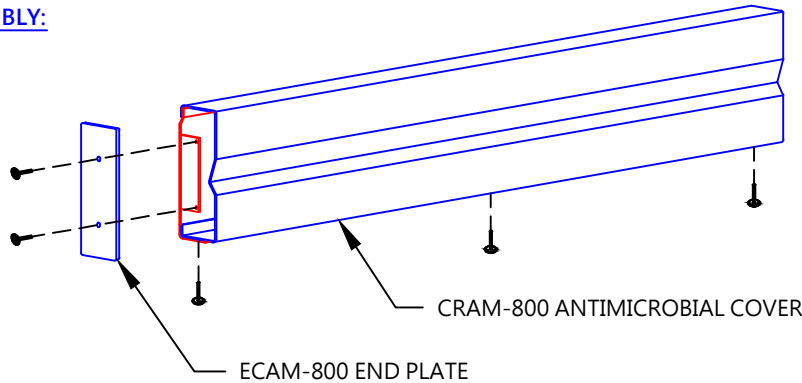

STANDARD BRACKET OPTIONS:

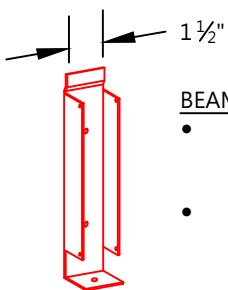

BEAM-800 BRACKET

- SECURES CRAM-800 ANTIMICROBIAL COVER TO WALL
- WINGS ALLOW FOR END PLATE ATTACHMENT

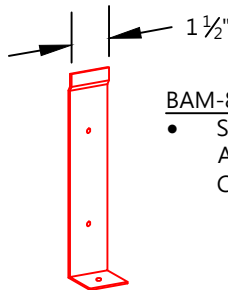

BAM-800 BRACKET

- SECURES CRAM-800 ANTIMICROBIAL COVER TO WALL

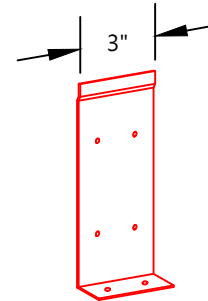

SPL-800 SPLICE

- SECURES CRAM-800 ANTIMICROBIAL COVER TO WALL
- TO BE USED AT SEAMS WHERE CRAM-800 ANTIMICROBIAL COVERS MEET

CUSTOMER:

PROJECT:

ARCHITECT:

SALES REP:

CRAM-800