

ProTek Systems, Inc.

PROTEK SYSTEMS, INC.
1250 WALLACE DR UNIT B
DELRAY BEACH, FL 33444
TELEPHONE: 800-598-2153
FAX: 561-395-4771
SALES@PROTEKMAIL.COM

CGP-55 PATTERNED STAINLESS STEEL CORNER GUARD

FEATURES:

- TYPE 304 PATTERNED STAINLESS STEEL
- MANUFACTURER'S STANDARD STAINLESS STEEL PATTERNS
- $\frac{3}{4}$ " RADIUS
- STOCK LENGTHS: 4FT, 8FT, OR 10FT
- CUSTOM WING SIZES AVAILABLE
- CUSTOM HEIGHTS AND ANGLES AVAILABLE
- OTHER FINISHES AVAILABLE

MOUNTING OPTIONS:

- ADHESIVE:
 - ADH-50 CONSTRUCTION ADHESIVE (SUPPLIED SEPARATELY AS REQUIRED)
- DRILLED:
 - CLEARANCE HOLES FOR #8 FASTENER
ABSS-11 #8 X $1\frac{1}{2}$ " OVAL HEAD SHEET METAL SCREW AND ABCW-132 STAINLESS CUP WASHER (FASTENERS BY OTHERS)
 - STANDARD SPACING: 3" FROM EACH END AND SPACED EVENLY NOT TO EXCEED 36" O.C.

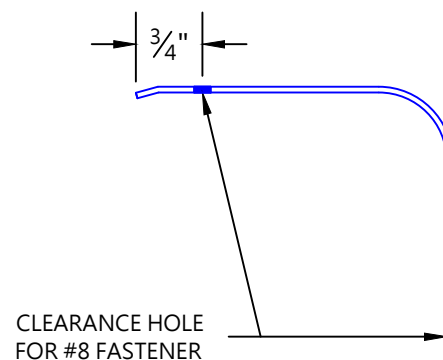
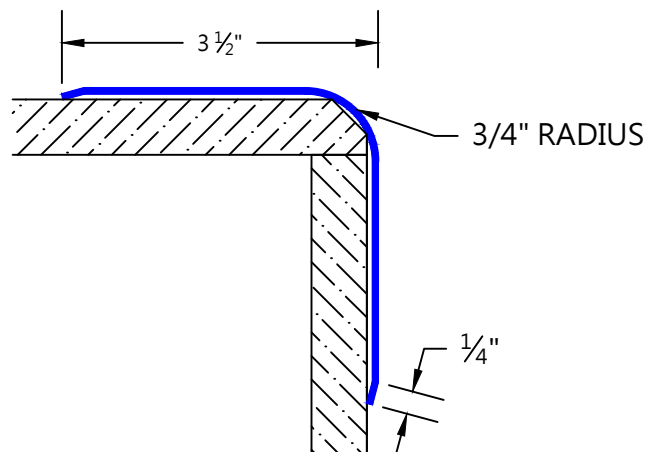
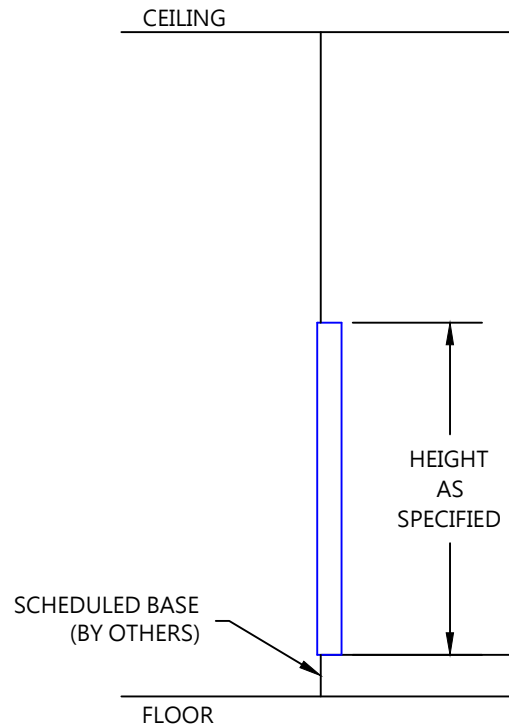

CUSTOMER:

PROJECT:

ARCHITECT:

SALES REP:

CGP-55