

ProTek Systems, Inc.

PROTEK SYSTEMS, INC.
 1250 WALLACE DR UNIT B
 DELRAY BEACH, FL 33444
 TELEPHONE: 800-598-2153
 FAX: 561-395-4771
 SALES@PROTEKMAIL.COM

CRS-200 STAINLESS STEEL WALL GUARD

FEATURES:

- COVER: 16 GAUGE TYPE 304 #4 SATIN STAINLESS STEEL
- END PLATES: 11 GAUGE TYPE 304 #4 SATIN STAINLESS STEEL
- BRACKETS: 16 GAUGE TYPE 304 #4 SATIN STAINLESS STEEL
- STOCK LENGTHS: 8FT OR 10FT
- ALL RUNS TERMINATE WITH END PLATES
- END PLATES FASTEN DIRECTLY TO WALL BRACKETS
- CUSTOM LENGTHS AND HEIGHTS AVAILABLE
- OTHER FINISHES AVAILABLE
- WALL FASTENERS BY OTHERS

ASSEMBLY:

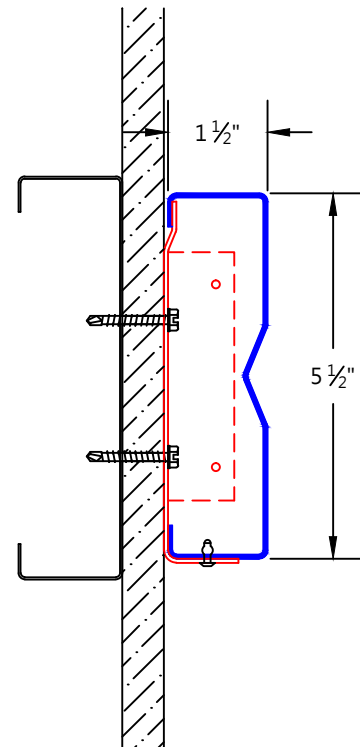
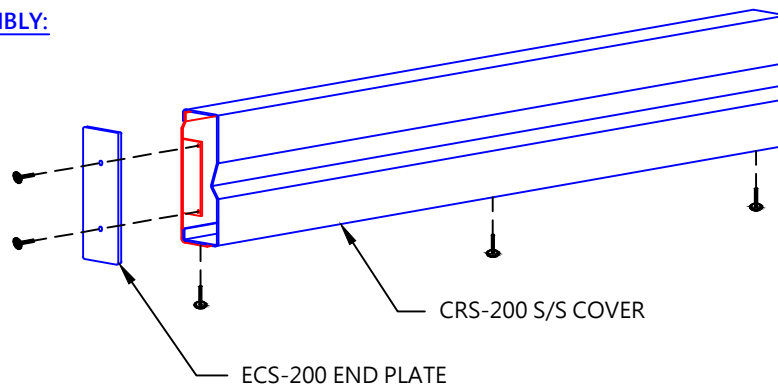

STANDARD BRACKET OPTIONS:

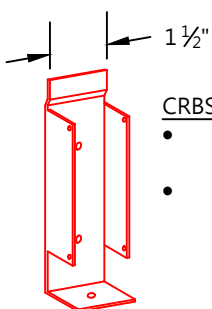

CRBSE-200 BRACKET

- SECURES CRS-200 S/S COVER TO WALL
- WINGS ALLOW FOR END PLATE ATTACHMENT

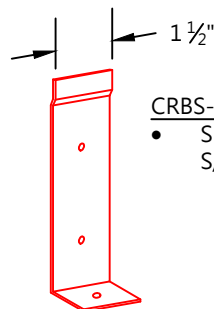

CRBS-200 BRACKET

- SECURES CRS-200 S/S COVER TO WALL

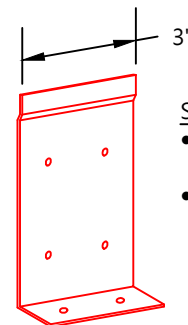

SPL-200 SPLICE

- SECURES CRS-200 S/S COVER TO WALL
- TO BE USED AT SEAMS WHERE CRS-200 S/S COVERS MEET

CUSTOMER:

PROJECT:

ARCHITECT:

SALES REP:

CRS-200