

ProTek Systems, Inc.

PROTEK SYSTEMS, INC.
2799 N.W. 2ND AVE
BOCA RATON, FL 33431
TELEPHONE: 800-598-2153
FAX: 561-395-4771
SALES@PROTEKMAIL.COM

CGD-404 DECORATIVE ALUMINUM CORNER GUARD

FEATURES:

- ALLOY 5052-H32 .080" THICK ALUMINUM WITH DECORATIVE POWDER COAT FINISH
- STOCK LENGTHS: 4FT OR 8FT
- CUSTOM WING SIZES AVAILABLE
- CUSTOM HEIGHTS AND ANGLES AVAILABLE

DECORATIVE OPTIONS:

- WOOD GRAIN
- MARBLE
- GRANITE
- PHOTOWALL

MOUNTING OPTIONS:

- ADHESIVE:
 - ADH-50 CONSTRUCTION ADHESIVE (SUPPLIED SEPARATELY AS REQUIRED)
- DRILLED:
 - CLEARANCE HOLES FOR #8 FASTENER ABSS-11 #8 X 1 1/2" OVAL HEAD SHEET METAL SCREW AND ABCW-132 STAINLESS CUP WASHER (FASTENERS BY OTHERS).
 - STANDARD SPACING: 3" FROM EACH END AND SPACED EVENLY NOT TO EXCEED 36" O.C.

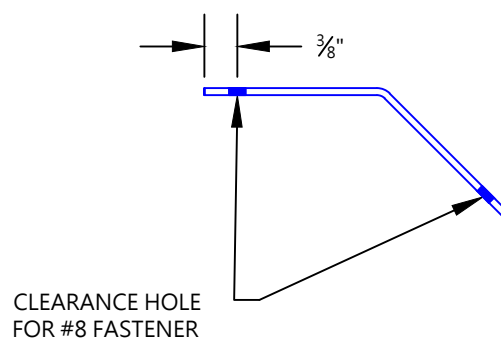
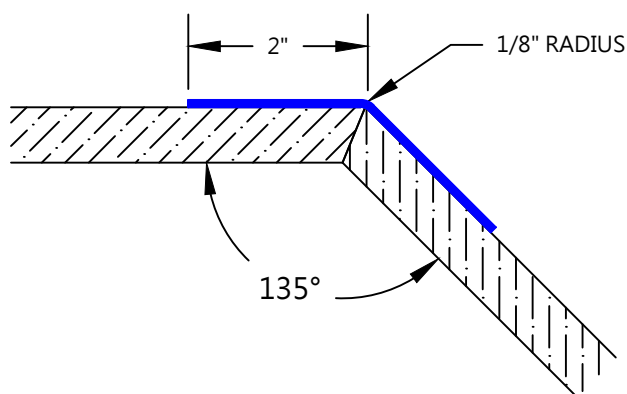
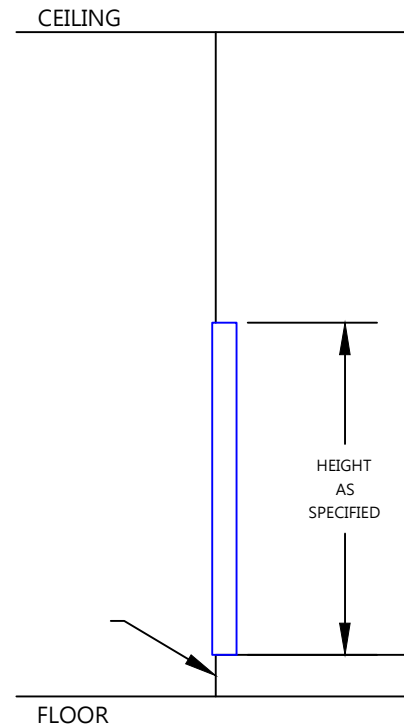

REV. 10/15/2012

CUSTOMER:

PROJECT:

ARCHITECT:

SALES REP:

CGD-404