

ProTek Systems, Inc.

PROTEK SYSTEMS, INC.
2799 N.W. 2ND AVE
BOCA RATON, FL 33431
TELEPHONE: 800-598-2153
FAX: 561-395-4771
SALES@PROTEKMAIL.COM

HR-100 STAINLESS STEEL HANDRAIL

FEATURES:

- 1 1/2" O.D. TYPE 304 BRUSHED STAINLESS HAND RAILING TUBING
- .050" WALL THICKNESS
- STOCK LENGTHS: 236" (6.0 M)
- MATCHING RETURNS, CORNERS, AND SPLICES AVAILABLE
- OTHER FINISHES AVAILABLE
- CUSTOM LENGTHS AND ANGLES AVAILABLE

MOUNTING OPTIONS:

- MOUNTING HARDWARE INCLUDED
- READY TO INSTALL

OPTIONAL BRACKET STYLES:

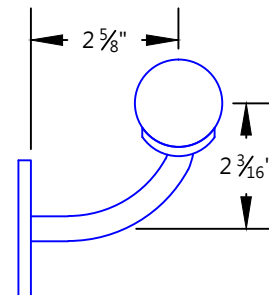

HR-15B3 BRACKET
• LONG ARM SCREW MOUNT

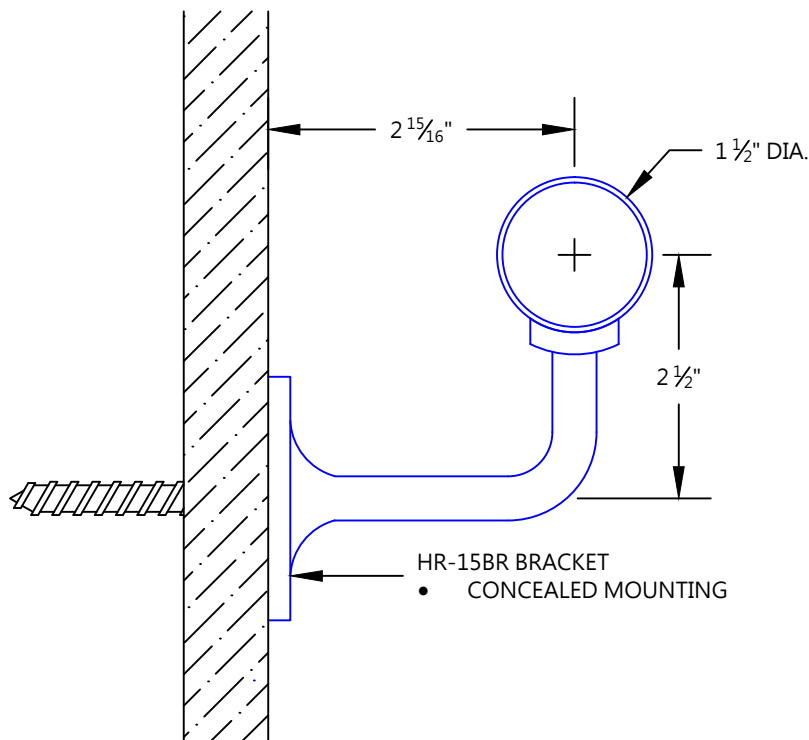

HR-15BR BRACKET
• CONCEALED MOUNTING

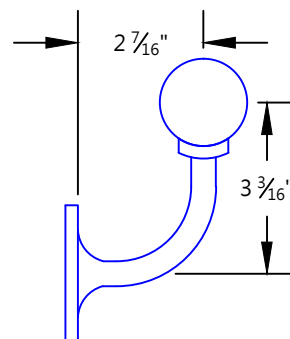

HR-15T BRACKET
• SHORT ARM SCREW MOUNT

REV. 10/15/2012

CUSTOMER:

PROJECT:

ARCHITECT:

SALES REP:

HR-100

ProTek Systems, Inc.

PROTEK SYSTEMS, INC.
 2799 N.W. 2ND AVE
 BOCA RATON, FL 33431
 TELEPHONE: 800-598-2153
 FAX: 561-395-4771
 SALES@PROTEKMAIL.COM

HR-100 STAINLESS STEEL HANDRAIL - FITTINGS

FEATURES:

- TYPE 304 BRUSHED STAINLESS
- FOR USE WITH 1 1/2" DIA. TUBING
- SPLICES AND CUSTOM ANGLES AVAILABLE
- OTHER FINISHES AVAILABLE

MOUNTING OPTIONS:

- MOUNTING HARDWARE INCLUDED
- READY TO INSTALL

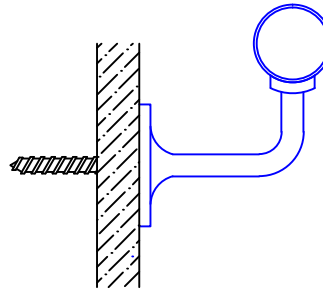

HR-15D DOME END CAP

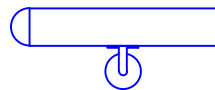
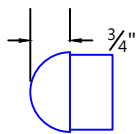

INSTALLED PREVIEW

HR-15H SHARP RADIUS 90° CORNER

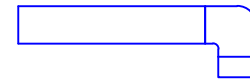
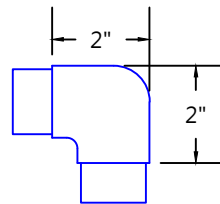

INSTALLED PREVIEW

HR-15R 90° RETURNS

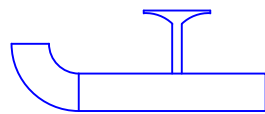
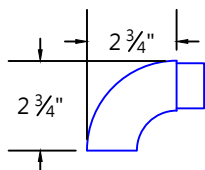

INSTALLED PREVIEW

HR-15C EZ RADIUS 90° CORNER

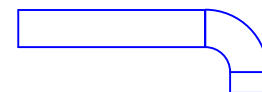
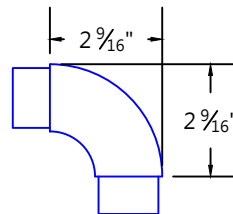

INSTALLED PREVIEW

HR-15B 90° BALL TYPE END CAP

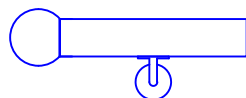
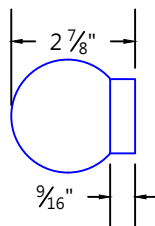

INSTALLED PREVIEW

HR-15MC MITRED STYLE 90° CORNER

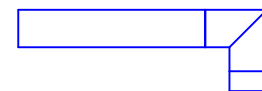
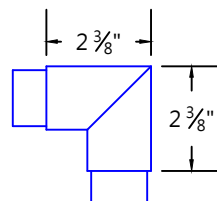

INSTALLED PREVIEW

REV. 10/15/2012

CUSTOMER:

PROJECT:

ARCHITECT:

SALES REP:

HR-100