

ProTek Systems, Inc.

PROTEK SYSTEMS, INC.
 2799 N.W. 2ND AVE
 BOCA RATON, FL 33431
 TELEPHONE: 800-598-2153
 FAX: 561-395-4771
 SALES@PROTEKMAIL.COM

CRDA-200 DECORATIVE ALUMINUM WALL GUARD

FEATURES:

- COVER: ALLOY 5052-H32 .063" THICK ALUMINUM WITH DECORATIVE POWDER COAT FINISH
- END PLATES: ALLOY 5052-H32 .080" THICK ALUMINUM WITH DECORATIVE POWDER COAT FINISH
- BRACKETS: ALLOY 5052-H32 .063" THICK ALUMINUM
- STOCK LENGTHS: 8FT OR 10FT
- ALL RUNS TERMINATE WITH END PLATES
- END PLATES FASTEN DIRECTLY TO WALL BRACKETS
- CUSTOM LENGTHS AND HEIGHTS AVAILABLE
- OTHER FINISHES AVAILABLE
- WALL FASTENERS BY OTHERS

ASSEMBLY:

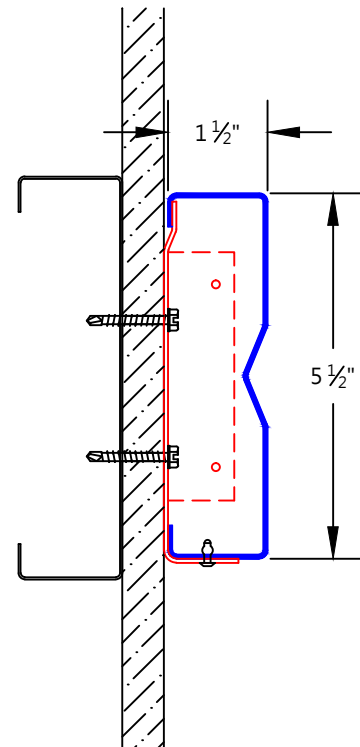
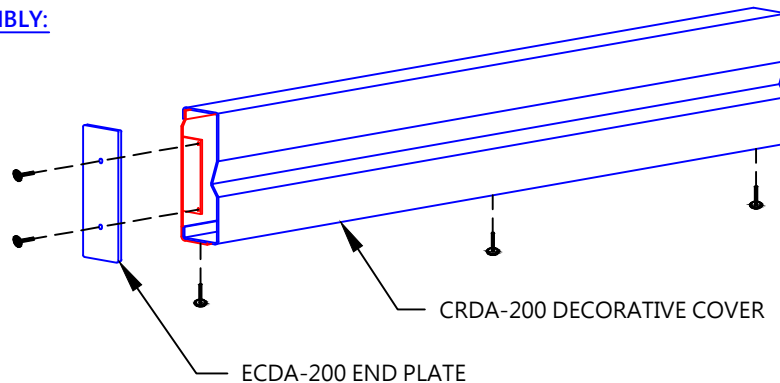

STANDARD BRACKET OPTIONS:

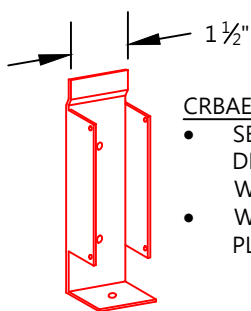

CRBAE-200 BRACKET

- SECURES CRDA-200 DECORATIVE COVER TO WALL
- WINGS ALLOW FOR END PLATE ATTACHMENT

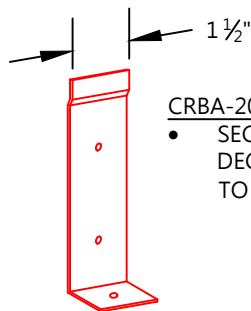

CRBA-200 BRACKET

- SECURES CRDA-200 DECORATIVE COVER TO WALL

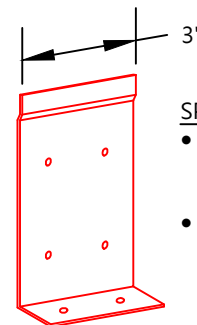

SPLA-200 SPLICE

- SECURES CRDA-200 DECORATIVE COVER TO WALL
- TO BE USED AT SEAMS WHERE CRDA-200 DECORATIVE COVERS MEET

REV. 10/15/2012

CUSTOMER:

PROJECT:

ARCHITECT:

SALES REP:

CRDA-200